

Work happily



V1.3

naggura'swop

naggura.com

Our products

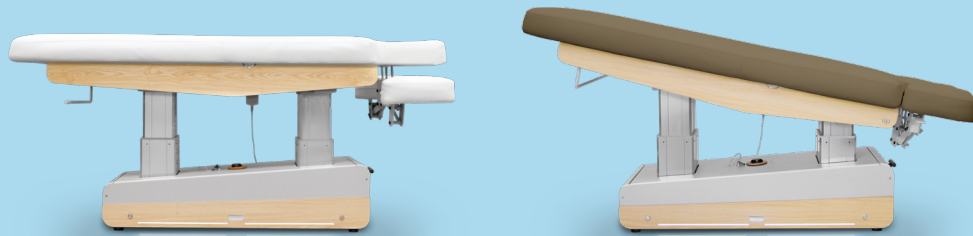

The Swop S4 Up Spa is an electrical 3-section table with a one-piece mattress, double column, wooden structure, wheels, LED light, 3 memory positions and reset function, TwinLift armrest system and heating.

Panel collections

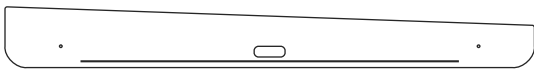

Nordic
METAL

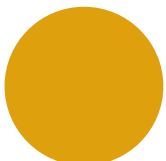

Yellow

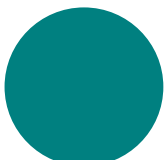

Blue

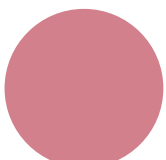

Pink

Foll
METAL



Ash

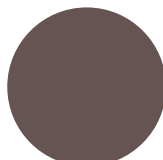

Clay

Iron
METAL

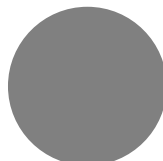

Inox

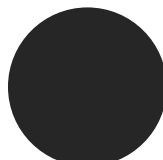

Black

Om
WOOD



Oak



Wenge

Techno
PMMA



Fluor



Fuxia



Ice

SWOP S4 UP SPA



Dimensions

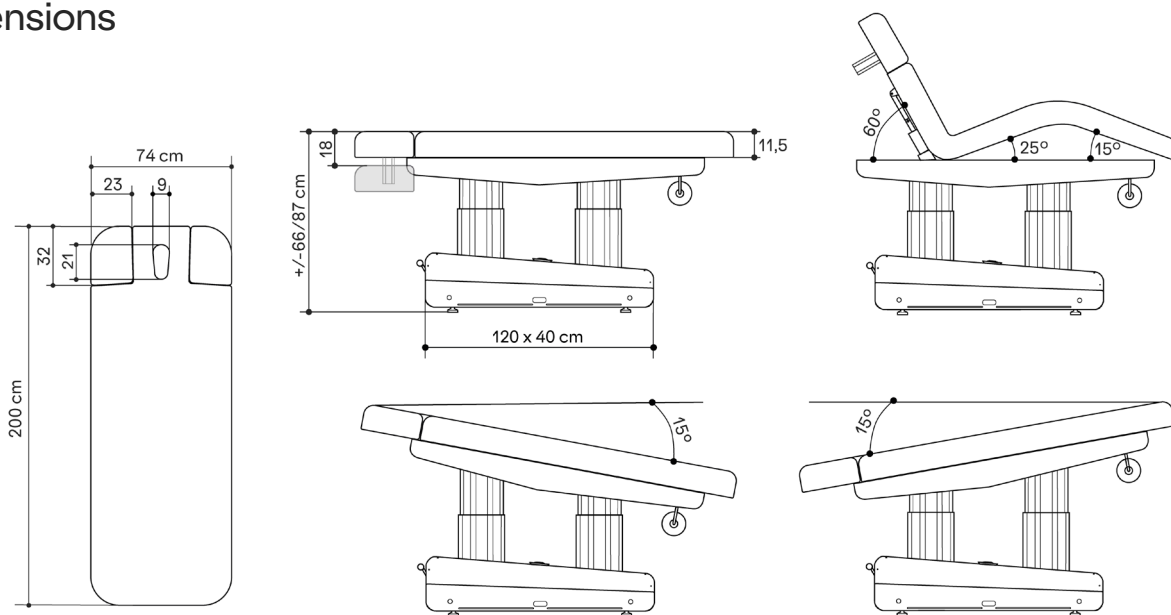

General specifications

MOTORS

4 engines (height, inclination, footrest, backrest)

DIMENSIONS (LENGTH X WIDTH)

200 x 74 cm

HEIGHT (MIN. AND MAX.)

66/87 cm

WEIGHT

135 kg

WARRANTY

2 years on table & upholstery

THICKNESS

11,5 cm (10 cm latex and 1,5 cm wood base)

DENSITY

30 kg/m³

LIFTING CAPACITY

300 kg

OPERATION

Hand controller (included)/
Foot controller (optional)

POWER SUPPLY

230 V - 50/60 Hz

MAX. INTENSITY

2 A

ELECTRIC MOTOR

6.000 N

FEATURES

TwinLift armrest system
Heating
Roll holder
Wheels

CUSHION

Upholstery Seamless
round edges

Naggura Skin upholstery:
100% vinyl compound in
white.

Superior abrasion resistance:
>250.000 cycles.
Protection against germs
and UV rays.